

Toledo.



Model-Nr. 420
(PG 1) Olše áste ný masiv

Model-Nr. 421
(PG 2) áste ný masiv-dub

SEDEA
SEZNAM PRODEJNÍCH CEN



Emissionsgeprüft
Schadstoffgeprüft
Regelmäßige
Produkt-
überwachung

www.tuv.com
ID 1111253053





Nabídka korpus a předních front

Prosím udejte v každé objednávce správnou barevnou kombinaci předních frontů a korpusů!

Barevná provedení:

korpus a front



vnitřní dekor



přední fronty se sklem

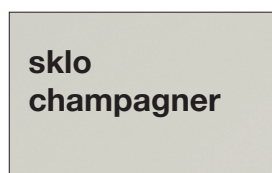
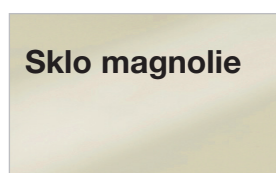

Zrcadlo



KVALITA V DETAILU

- Zadní stěny: sololit s drážkou
- otočné dveře s 105°- úhlem otevírání a tlumením dovírání
- Police: 22 mm silné, kovové podložky
- kovové šatní tyče a kovové doplňky do skříní, zatížení 40 kg
- všechna kování jsou kovová, určená pro vyšší zatížení
- Maximální komfort při dodání doplňkového nábytku

Toledo.



šírky korpusů

Skřín s křídlými dveřmi

Šířka	Stra-	Sokl	Stra-	Sokl	Stra-	Sokl	Stra-	Sokl	Stra-	Sokl	Šířka efektivní
50	1,5	47,5	1,5								50,5 cm
100	1,5	96,4	1,5								99,4 cm
150	1,5	96,4	1,5	47,5	1,5						148,4 cm
200	1,5	96,4	1,5	96,4	1,5						197,3 cm
250	1,5	96,4	1,5	47,5	1,5	96,4	1,5				246,3 cm
300	1,5	96,4	1,5	96,4	1,5	96,4	1,5				295,2 cm
350	1,5	96,4	1,5	96,4	1,5	47,5	1,5	96,4	1,5		344,2 cm
400	1,5	96,4	1,5	96,4	1,5	96,4	1,5	96,4	1,5		393,1 cm

Skřín s posuvnými dveřmi

Šířka	Stra-	Sokl	Stra-	Sokl	Stra-	Sokl	Stra-	Sokl	Stra-	Sokl	Šířka efektivní
200	1,5	96,4	1,5	96,4	1,5						197,3 cm
250	1,5	80,1	1,5	80,1	1,5	80,1	1,5				246,3 cm
300	1,5	96,4	1,5	96,4	1,5	96,4	1,5				295,2 cm
330	1,5	80,1	1,5	80,1	1,5	80,1	1,5	80,1	1,5		327,9 cm
400	1,5	96,4	1,5	96,4	1,5	96,4	1,5	96,4	1,5		393,1 cm

furnplan



Emissionsgeprüft
Schadstoffgeprüft
Regelmäßige
Produkt-
überwachung

www.tuv.com
ID 1111253053

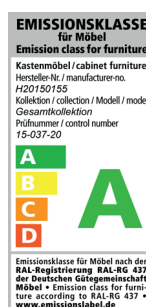
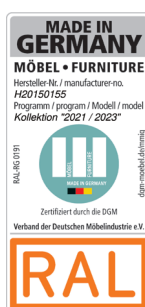

Toledo.



Emissionsgeprüft
Schadstoffgeprüft
Regelmäßige
Produkt-
überwachung

www.tuv.com
ID 1111253053



Toledo.



Emissionsgeprüft
Schadstoffgeprüft
Regelmäßige
Produkt-
überwachung
www.tuv.com
ID 1111253053



Toledo.



Emissionsgeprüft
Schadstoffgeprüft
Regelmäßige
Produkt-
überwachung
www.tuv.com
ID 1111253053



Toledo.



Emissionsgeprüft
Schadstoffgeprüft
Regelmäßige
Produkt-
überwachung
www.tuv.com
ID 1111253053



Toledo.



Emissionsgeprüft
Schadstoffgeprüft
Regelmäßige
Produkt-
überwachung
www.tuv.com
ID 1111253053





Skříně s křídlovými dveřmi
 bez horní rampy

Vnitřní vybavení:

2 police, 1 tyč na šaty pro každý vnitřní prostor

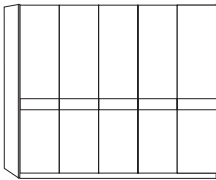
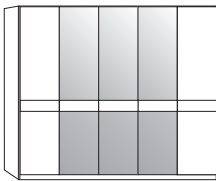
Všechny otoč. dveře s tlum. Dovíráním

Popis	Rozměry v cm			Č. výr.	PG 1 CZK	PG 2 CZK
	B	v.	h			
 Vsazení jednoduché 1 door LHH 1 door RHH 2 doors 3 doors 4 doors 5 doors 6 doors 7 doors 8 doors	50	216	58	597	16669	17753
	50	216	58	598	16669	17753
	100	216	58	532	29340	31915
	150	216	58	531	39978	43299
	200	216	58	534	48855	53327
	250	216	58	535	59426	64982
	300	216	58	536	70064	76162
	350	216	58	537	85716	93644
	400	216	58	334	96694	105502
 Dřevěné dveře a dveře se zrcadlem v provedení Parsol-Bronz, jednoduché vsazení 1 door 1 mirrored door, LHH 1 door 1 mirrored door, RHH 2 doors 1 mirrored door left 2 doors 1 mirrored door, RHH 2 doors 2 mirrored doors 3 doors 1 mirrored door 4 doors 2 mirrored doors 5 doors 1 mirrored door 5 doors 2 mirrored doors 5 doors 3 mirrored doors 6 doors 2 mirrored doors 6 doors 4 mirrored doors 7 doors 1 mirrored door 7 doors 3 mirrored doors 7 doors 5 mirrored doors 8 doors 2 mirrored doors 8 doors 4 mirrored doors 8 doors 6 mirrored doors	50	216	58	511	11045	11045
	50	216	58	510	11045	11045
	100	216	58	507	23377	24868
	100	216	58	508	23377	24868
	100	216	58	391	18160	18160
	150	216	58	593	34896	37132
	200	216	58	594	39369	41605
	250	216	58	599	55089	59426
	250	216	58	530	49939	53327
	250	216	58	595	45535	47703
	300	216	58	596	60510	64982
	300	216	58	526	51159	53327
	350	216	58	527	81176	87817
	350	216	58	528	70606	75552
	350	216	58	529	60510	63356
	400	216	58	336	86665	93644
400	216	58	337	76772	81786	
400	216	58	338	66744	69386	



Skříně s křídlovými dveřmi bez horní rampy

Vnitřní vybavení:

2 police, 1 tyč na šaty pro každý vnitřní prostor

Všechny otoč. dveře s tlum. Dovíráním

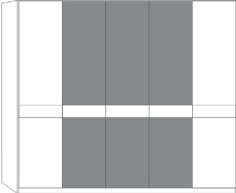
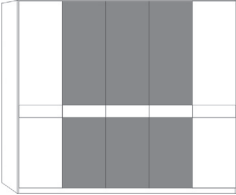
Popis	Rozměry v cm			Č. výr.	PG 1 CZK	PG 2 CZK			
	B	v.	h						
 <p>dřevěné dveře a dveře se sklem v barvě magnolie</p> <p>Vsazení jednoduché</p>	1 door	1 glass door, LHH	50	216	58	822	11316	11316	
	1 door	1 glass door, RHH	50	216	58	823	11316	11316	
	2 doors	1 glass door, LHH	100	216	58	824	23784	25207	
	2 doors	1 glass door, RHH	100	216	58	825	23784	25207	
	2 doors	2 glass doors	100	216	58	826	18905	18905	
	3 doors	1 glass door	150	216	58	827	35235	37742	
	4 doors	2 glass doors	200	216	58	828	39978	42147	
	5 doors	1 glass door	250	216	58	829	55428	59426	
	5 doors	3 glass doors	250	216	58	830	46009	48855	
	6 doors	2 glass doors	300	216	58	831	61120	65592	
	6 doors	4 glass doors	300	216	58	832	51633	54411	
	7 doors	1 glass door	350	216	58	833	81176	87817	
	7 doors	3 glass doors	350	216	58	834	71690	76772	
	7 doors	5 glass doors	350	216	58	835	62136	64982	
	8 doors	2 glass doors	400	216	58	836	87343	94457	
	8 doors	4 glass doors	400	216	58	837	77721	82870	
	8 doors	6 glass doors	400	216	58	838	68370	71216	
	 <p>dřevěné dveře a dveře s bílým sklem</p> <p>Vsazení jednoduché</p>	1 door	1 glass door, LHH	50	216	58	779	11316	11316
		1 door	1 glass door, RHH	50	216	58	780	11316	11316
		2 doors	1 glass door, LHH	100	216	58	781	23784	25207
2 doors		1 glass door, RHH	100	216	58	782	23784	25207	
2 doors		2 glass doors	100	216	58	783	18905	18905	
3 doors		1 glass door	150	216	58	784	35235	37742	
4 doors		2 glass doors	200	216	58	785	39978	42147	
5 doors		1 glass door	250	216	58	786	55428	59426	
5 doors		3 glass doors	250	216	58	787	46009	48855	
6 doors		2 glass doors	300	216	58	788	61120	65592	
6 doors		4 glass doors	300	216	58	789	51633	54411	
7 doors		1 glass door	350	216	58	790	81176	87817	
7 doors		3 glass doors	350	216	58	791	71690	76772	
7 doors		5 glass doors	350	216	58	792	62136	64982	
8 doors		2 glass doors	400	216	58	793	87343	94457	
8 doors		4 glass doors	400	216	58	794	77721	82870	
8 doors		6 glass doors	400	216	58	795	68370	71216	

Skříně s křídlovými dveřmi
 bez horní rampy

Vnitřní vybavení:

2 police, 1 tyč na šaty pro každý vnitřní prostor

Všechny otoč. dveře s tlum. Dovíráním

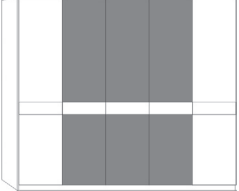
Popis	Rozměry v cm			Č. výr.	PG 1 CZK	PG 2 CZK		
	B	v.	h					
 <p>Dřevěné dveře a dveře se sklem v barvě champagner s hladkým příčným vsazením</p>	1 door	1 glass door, LHH	50	216	58	724	11316	11316
	1 door	1 glass door, RHH	50	216	58	725	11316	11316
	2 doors	1 glass door, LHH	100	216	58	726	23784	25207
	2 doors	1 glass door, RHH	100	216	58	727	23784	25207
	2 doors	2 glass doors	100	216	58	728	18905	18905
	3 doors	1 glass door	150	216	58	729	35235	37742
	4 doors	2 glass doors	200	216	58	730	39978	42147
	5 doors	1 glass door	250	216	58	731	55428	59426
	5 doors	3 glass doors	250	216	58	732	46009	48855
	6 doors	2 glass doors	300	216	58	733	61120	65592
	6 doors	4 glass doors	300	216	58	734	51633	54411
	7 doors	1 glass door	350	216	58	735	81176	87817
	7 doors	3 glass doors	350	216	58	736	71690	76772
	7 doors	5 glass doors	350	216	58	737	62136	64982
	8 doors	2 glass doors	400	216	58	738	87343	94457
	8 doors	4 glass doors	400	216	58	739	77721	82870
	8 doors	6 glass doors	400	216	58	740	68370	71216

Skříně s vnějšími zásuvkami
 s dřevěnými dveřmi, 3 výsuvy a zrcadlovými dveřmi, bez paspartového rámu

Vnitřní vybavení:

2 police, 1 tyč na šaty pro každý vnitřní prostor

Všechny otoč. dveře s tlum. Dovíráním

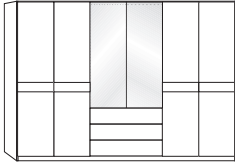
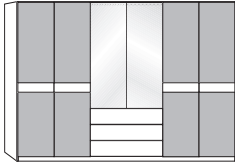
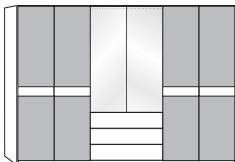
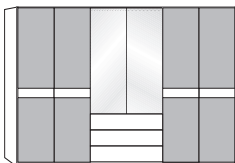
Popis	Rozměry v cm			Č. výr.	PG 1 CZK	PG 2 CZK
	B	v.	h			
 Vsazení jednoduché 3 doors 3 drawers 50 cm, 1 mirrored door 4 doors 3 drawers à 100 cm, 2 mirrored doors 5 doors 3 drawers 50 cm, 1 mirrored door 6 doors 3 drawers à 100 cm, 2 mirrored doors	150	216	58	474	44925	48245
	200	216	58	473	54411	57189
	250	216	58	496	62136	67828
	300	216	58	477	73520	78398
 dveře se sklem v barvě magnolie Vsazení jednoduché 3 doors 3 drawers 50 cm, 1 mirrored door 4 doors 3 drawers à 100 cm, 2 mirrored doors 5 doors 3 drawers 50 cm, 1 mirrored door 6 doors 3 drawers à 100 cm, 2 mirrored doors	150	216	58	493	35981	37132
	200	216	58	494	45535	47093
	250	216	58	495	46009	47703
	300	216	58	497	57189	58816
 Puertas de cristal blanco travesaño en simple 3 doors 3 drawers 50 cm, 1 mirrored door 4 doors 3 drawers à 100 cm, 2 mirrored doors 5 doors 3 drawers 50 cm, 1 mirrored door 6 doors 3 drawers à 100 cm, 2 mirrored doors	150	216	58	462	35981	37132
	200	216	58	463	45535	47093
	250	216	58	464	46009	47703
	300	216	58	465	57189	58816
 dveře v provedení sklo champagner Vsazení jednoduché 3 doors 3 drawers 50 cm, 1 mirrored door 4 doors 3 drawers à 100 cm, 2 mirrored doors 5 doors 3 drawers 50 cm, 1 mirrored door 6 doors 3 drawers à 100 cm, 2 mirrored doors	150	216	58	420	35981	37132
	200	216	58	421	45535	47093
	250	216	58	422	46009	47703
	300	216	58	426	57189	58816

Rohová skříň
s horní rampou

Vnitřní vybavení:

1 police, 1 tyč na šaty

Všechny otoč. dveře s tlum. Dovíráním

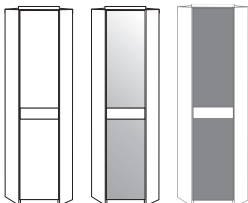
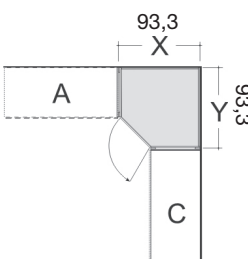
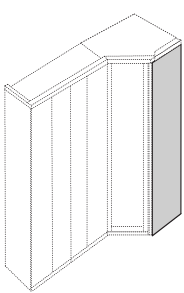
Popis	Rozměry v cm			Č. výr.	PG 1 CZK	PG 2 CZK
	B	v.	h			
 <p>Vsazení jednoduché</p> <ul style="list-style-type: none"> - wooden door - Mirrored door in Parsol bronze glass - Front glass magnolia - Front glass white - Front glass champagne 	93	220	93	154	20396	21548
	93	220	93	155	15924	15924
	93	220	93	592	15924	15924
	93	220	93	600	15924	15924
	93	220	93	156	15924	15924
						
<p>Není dodáváno ve spojení se skříněmi s posuvnými dveřmi - lze použít pouze ve spojení mezi dvěma skříněmi s křídlovými dveřmi!</p>						
 <p>Costado terminal incl. retroceso de cornisa para armario de rincón ampliado, de utilización bilateral (izquierda y derecha)</p>	56	216	1	090	2846	2846
<p>Jsou zapotřebí v případě, pokud je sestava ukončena vestavěnou rohovou skříní. Je-li rohová skříň samostatná, jsou zapotřebí 2 samostatné vnější stěny.</p>						



**Koncové skříně**

s otočnými dveřmi, zkosené, s paspartovým rámem

Vnitřní vybavení:

4 police

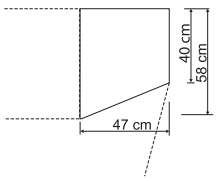
Všechny otoč. dveře s tlum. Dovíráním

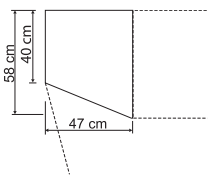
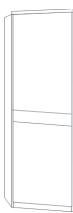
Popis	Rozměry v cm			Č. výr.	PG 1 CZK	PG 2 CZK
	B	v.	h			
 <p>Vsazení jednoduché otočné doprava:</p> <p>- wooden door</p>  <p>Nelze samostatně postavit! Není dodáváno ve spojení se skříněmi s posuvnými dveřmi!</p>	47	220	58	180	17753	18905
 <p>Vsazení jednoduché otočné doleva:</p> <p>- wooden door</p>  <p>Nelze samostatně postavit! Není dodáváno ve spojení se skříněmi s posuvnými dveřmi!</p>	47	220	58	185	17753	18905





Anbau an ausgebauten Eckschrank nur in Kombination mit Abschlussseite möglich!



Doplňkové prvky

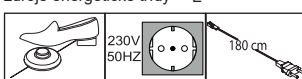

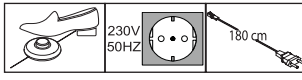

pro skříně s křídlovými dveřmi

Popis	Rozměry v cm			Č. výr.	PG 1 CZK	PG 2 CZK
	B	v.	h			
 <p>LED-liniové nastavné osvětlení</p> <p>2 items</p> <p>3 items</p> <p>Tento výrobek obsahuje světelné zdroje energetické třídy E</p> 	60	6	19	775	6098	6098
	60	6	19	776	8131	8131
 <p>Paspardový rám, bez osvětlení</p> <p>- for width 50 cm</p> <p>- for width 100 cm</p> <p>- for width 150 cm</p> <p>- for width 200 cm</p> <p>- for width 250 cm</p> <p>- for width 300 cm</p> <p>- for width 350 cm</p> <p>- for width 400 cm</p>	50	3,2	12,5	936	1423	1423
	100	3,2	12,5	937	1423	1423
	150	3,2	12,5	930	1626	1626
	200	3,2	12,5	938	1897	1897
	250	3,2	12,5	932	1965	1965
	300	3,2	12,5	931	1965	1965
	350	3,2	12,5	934	3388	3388
	400	3,2	12,5	935	3456	3456
 <p>s power LED osvětlením</p> <p>1 light - for width 50 cm</p> <p>2 lights - for width 100 cm</p> <p>3 lights - for width 150 cm</p> <p>4 lights - for width 200 cm</p> <p>5 lights - for width 250 cm</p> <p>6 lights - for width 300 cm</p> <p>7 lights - for width 350 cm</p> <p>8 lights - for width 400 cm</p> <p>Tento výrobek obsahuje světelné zdroje energetické třídy F</p> 	50	3,2	12,5	956	4201	4201
	100	3,2	12,5	957	6979	6979
	150	3,2	12,5	959	7589	7589
	200	3,2	12,5	939	10232	10232
	250	3,2	12,5	940	11994	11994
	300	3,2	12,5	942	13484	13484
	350	3,2	12,5	943	18498	18498
	400	3,2	12,5	944	19583	19583



Paspartový rám

pro skříně s křídlovými dveřmi a skříně se zásuvkami

Popis	Rozměry v cm			Č. výr.	PG 1 CZK	PG 2 CZK	
	B	v.	h				
 <p>bez osvětlení, Šířka každého bočního sloupku 3,2 cm</p> <p>- for width 50 cm</p> <p>- for width 100 cm</p> <p>- for width 150 cm</p> <p>- for width 200 cm</p> <p>- for width 250 cm</p> <p>- for width 300 cm</p> <p>- for width 350 cm</p> <p>- for width 400 cm</p>	56,4	220	6,7	983	2372	2372	
	106,4	220	6,7	984	2507	2507	
	156,4	220	6,7	985	2507	2507	
	206,4	220	6,7	986	2643	2643	
	256,4	220	6,7	987	2710	2710	
	306,4	220	6,7	988	2778	2778	
	356,4	220	6,7	989	3862	3862	
	406,4	220	6,7	990	3930	3930	
	Šířka na každé straně: 6,5 cm						
	- for width 50 cm	63	220	12,9	980	5692	5692
	- for width 100 cm	113	220	12,9	981	5692	5692
	- for width 150 cm	163	220	12,9	982	5760	5760
	- for width 200 cm	213	220	12,9	975	5963	5963
	- for width 250 cm	263	220	12,9	976	6098	6098
- for width 300 cm	313	220	12,9	977	6166	6166	
- for width 350 cm	363	220	12,9	978	7386	7386	
- for width 400 cm	413	220	12,9	979	7454	7454	
 dodáváno do 30. 6. 2022!							
 <p>Paspartový rám, Šířka na každé straně bočnice: 3,2 cm</p> <p>4 lights - for width 200 cm</p> <p>5 lights - for width 250 cm</p> <p>6 lights - for width 300 cm</p> <p>7 lights - for width 350 cm</p> <p>8 lights - for width 400 cm</p>	206,4	220	12,9	915	11316	11316	
	256,4	220	12,9	917	13484	13484	
	306,4	220	12,9	918	15924	15924	
	356,4	220	12,9	919	19583	19583	
	406,4	220	12,9	924	21548	21548	
	Šířka na každé straně: 6,5 cm						
	4 lights - for width 200 cm	213	220	12,9	925	15178	15178
	5 lights - for width 250 cm	263	220	12,9	926	16669	16669
	6 lights - for width 300 cm	313	220	12,9	927	17753	17753
	7 lights - for width 350 cm	463	220	12,9	928	23784	23784
	8 lights - for width 400 cm	413	220	12,9	929	25613	25613
	 dodáváno do 30. 6. 2022!						

Tento výrobek obsahuje světelné zdroje energetické třídy F

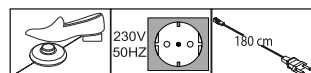

dodáváno do 30. 6. 2022!



Prosím, respektujte:



Při použití paspartového rámu se skříně rozšíří na vykazovanou šířku.

paspartové rámy použitelné jen pro jednotlivé skříně!

nelze ve spojení s rohovou nebo ukončovací skříní

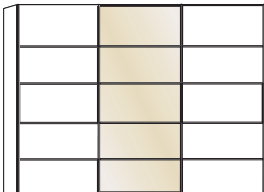

Skříně s posuvnými dveřmi, výška 217 cm
 bez horní rampy

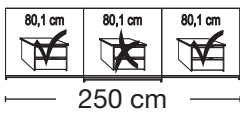
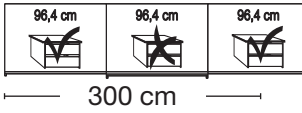
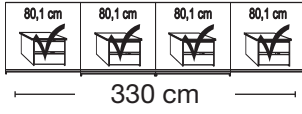
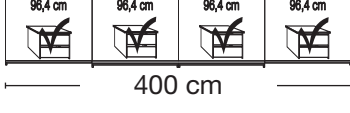
Vnitřní vybavení:
 2 police, 1 tyč na šaty

Popis	Rozměry v cm			Č. vyr.	PG 1 CZK	PG 2 CZK		
	B	v.	h					
kombinace front z masiv. dřeva a střed. dveří se zrcadlem, sklem magnolie, bílým, champagner	3 doors	250	217	67	498	66744	71216	
	3 doors	300	217	67	499	73520	82870	
	4 doors with synchronous opening	330	217	67	500	94457	100353	
	4 doors with synchronous opening	400	217	67	501	102656	115260	
 - Puerta central con Espejo Parsol Bronce	3 doors	250	217	67	480	62136	65592	
	3 doors	300	217	67	481	68844	75146	
	4 doors with synchronous opening	330	217	67	482	85716	88495	
	4 doors with synchronous opening	400	217	67	483	93644	100353	
 - Pro střední dveře sklo magnolie	3 doors	250	217	67	488	62136	65592	
	3 doors	300	217	67	489	68844	75146	
	4 doors with synchronous opening	330	217	67	490	85716	88495	
	4 doors with synchronous opening	400	217	67	491	93644	100353	
Rozdělení soklů  250 cm  300 cm  330 cm  400 cm	- prostřední dveře v provedení bílé sklo	3 doors	250	217	67	584	62136	65592
	3 doors	300	217	67	585	68844	75146	
	4 doors with synchronous opening	330	217	67	586	85716	88495	
	4 doors with synchronous opening	400	217	67	587	93644	100353	
- středové dveře sklo champagner	3 doors	250	217	67	682	62136	65592	
	3 doors	300	217	67	683	68844	75146	
	4 doors with synchronous opening	330	217	67	684	85716	88495	
	4 doors with synchronous opening	400	217	67	685	93644	100353	

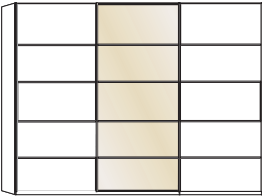
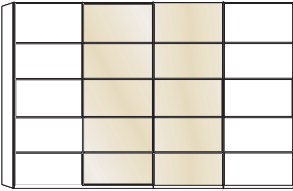
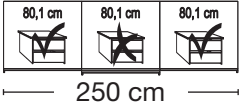
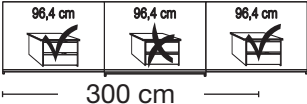
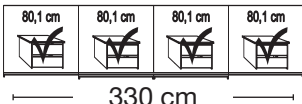
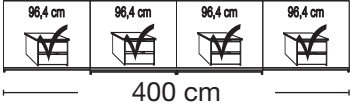

Skříně s posuvnými dveřmi, výška 236 cm
 bez horní rampy

 Vnitřní vybavení:
 2 police, 1 tyč na šaty

Popis	Rozměry v cm			Č. výr.	PG 1 CZK	PG 2 CZK	
	B	v.	h				
kombinace front z masiv. dřeva a střed. - Front dřevo masiv dveři se zrcadlem, sklem magnolie, bílým, champagner	3 doors	250	236	67	580	74536	79957
	3 doors	300	236	67	581	81786	92899
	4 doors- with synchronous opening	330	236	67	582	104825	113091
	4 doors	400	236	67	583	114514	129354
	- Prostřední dveře zrcadlo						
	3 doors	250	236	67	568	69386	73520
	3 doors	300	236	67	569	76772	84022
	4 doors- with synchronous opening	330	236	67	570	95203	99607
	- Prostřední dveře sklo magnolie						
	4 výsuvy à 50 cm 3 doors	250	236	67	576	69386	73520
	3 doors	300	236	67	577	76772	84022
	4 doors- with synchronous opening	330	236	67	578	95203	99607
Rozdělení soklů    	4 doors- with synchronous opening	400	236	67	579	104079	113091
	- prostřední dveře v provedení bílé sklo						
	3 doors	250	236	67	588	69386	73520
	3 doors	300	236	67	589	76772	84022
4 doors- with synchronous opening	330	236	67	590	95203	99607	
4 doors- with synchronous opening	400	236	67	591	104079	113091	
- středové dveře sklo champagner	3 doors	250	236	67	687	69386	73520
	3 doors	300	236	67	689	76772	84022
	4 doors- with synchronous opening	330	236	67	690	95203	99607
	4 doors	400	236	67	691	104079	113091

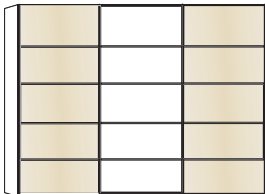
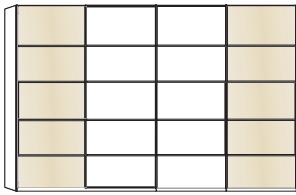
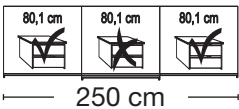
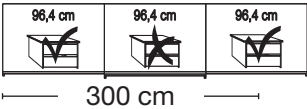
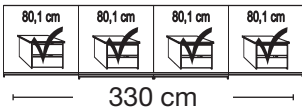
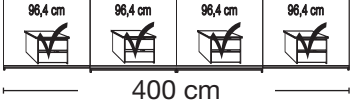
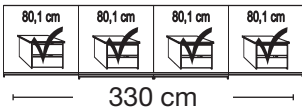
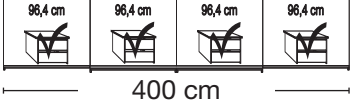

Skříně s posuvnými dveřmi, výška 217 cm
 bez horní rampy

Vnitřní vybavení:
 2 police, 1 tyč na šaty

Popis	Rozměry v cm			Č. výr.	PG 1 CZK	PG 2 CZK	
	B	v.	h				
kombinace front z masiv. dřeva a vnějších dveří se zrcadlem, sklem magnolie, bílým, champagner 	- střed. dveře masiv. dřevo, vnější dveře zrcadlo						
	3 doors	250	217	67	741	57799	60103
	3 doors	300	217	67	742	64304	67286
	4 doors- with synchronous opening	330	217	67	743	85716	88495
	4 doors- with synchronous opening	400	217	67	744	93644	100353
	- střed. dveře masiv. dřevo, vnější dveře sklo magnolie						
	3 doors	250	217	67	745	57799	60103
	3 doors	300	217	67	746	64304	67286
	4 doors- with synchronous opening	330	217	67	747	85716	88495
	4 doors- with synchronous opening	400	217	67	748	93644	100353
Rozdělení soklů  250 cm  300 cm  330 cm  400 cm	- střed. dveře masiv. dřevo, vnější dveře sklo bílé						
	3 doors	250	217	67	749	57799	60103
	3 doors	300	217	67	750	64304	67286
	4 doors- with synchronous opening	330	217	67	751	85716	88495
	4 doors	400	217	67	752	93644	100353
 330 cm  400 cm	- střed. dveře masiv. dřevo, vnější dveře sklo champagner						
	3 doors	250	217	67	753	57799	60103
	3 doors	300	217	67	754	64304	67286
	4 doors- with synchronous opening	330	217	67	755	85716	88495
	4 doors	400	217	67	756	93644	100353

Skříně s posuvnými dveřmi, výška 236 cm
 bez horní rampy

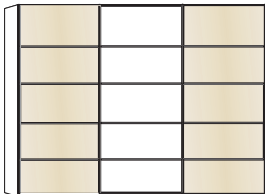
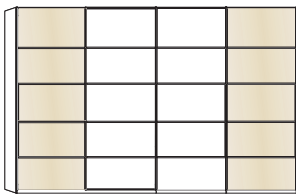
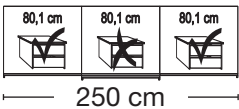
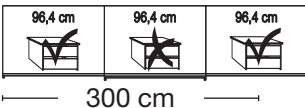
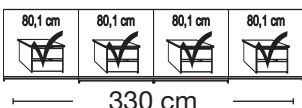
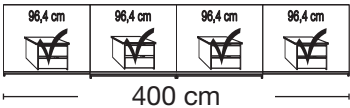



 Vnitřní vybavení:
 2 police, 1 tyč na šaty

Popis	Rozměry v cm			Č. vyr.	PG 1 CZK	PG 2 CZK
	B	v.	h			
kombinace front z masiv. dřeva a vnější dveři se zrcadlem, sklem magnolie, bílým, champagner						
- střed. dveře masiv. dřevo, vnější dveře zrcadlo						
 3 doors	250	236	67	757	64304	66947
3 doors	300	236	67	758	71690	75214
4 doors- with synchronous opening	330	236	67	774	95203	99607
4 doors- with synchronous opening	400	236	67	796	104079	113091
- střed. dveře masiv. dřevo, vnější dveře sklo magnolie						
 3 doors	250	236	67	797	64304	66947
3 doors	300	236	67	798	71690	75214
4 doors- with synchronous opening	330	236	67	799	95203	99607
4 doors- with synchronous opening	400	236	67	800	104079	113091
- střed. dveře masiv. dřevo, vnější dveře sklo bílé						
Rozdělení soklů 3 doors	250	236	67	801	64304	66947
 3 doors	300	236	67	802	71690	75214
4 doors- with synchronous opening	330	236	67	803	95203	99607
4 doors	400	236	67	804	104079	113091
 3 doors						
 3 doors	250	236	67	805	64304	66947
3 doors	300	236	67	806	71690	75214
4 doors- with synchronous opening	330	236	67	807	95203	99607
4 doors	400	236	67	808	104079	113091
- střed. dveře masiv. dřevo, vnější dveře sklo champagner						
 3 doors						
3 doors	300	236	67	806	71690	75214
4 doors- with synchronous opening	330	236	67	807	95203	99607
4 doors	400	236	67	808	104079	113091

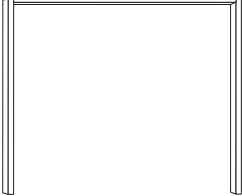

Paspartový rám pro skříně s posuvnými dveřmi, výška skříně 217 cm

s nebo bez osvětlení

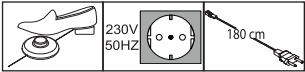
Popis	Rozměry v cm			Č. výr.	PG 1 CZK	PG 2 CZK
	B	v.	h			
 <p>bez osvětlení, Šířka na každé straně bočnice: 5 cm</p> <p>- for width 250 cm - for width 300 cm - for width 330 cm - for width 400 cm</p>	260	221	23	945	6979	6979
	310	221	23	946	7115	7115
	340	221	23	950	9419	9419
	410	221	23	951	9757	9757
	Paspartový rám					
	267	221	23	961	14568	14568
	317	221	23	962	14839	14839
	347	221	23	963	17753	17753
	417	221	23	964	18160	18160
 dodáváno do 30. 6. 2022!						
 <p>Paspartový rám, Šířka na každé straně bočnice: 5 cm</p> <p>6 lights - for width 250 cm 6 lights - for width 300 cm 8 lights - for width 330 cm 8 lights - for width 400 cm</p>	260	221	23	948	17753	17753
	310	221	23	949	18160	18160
	340	221	23	952	21073	21073
	410	221	23	953	21548	21548
	Paspartový rám					
	267	221	23	965	25207	25207
	317	221	23	966	25613	25613
	347	221	23	967	27849	27849
	417	221	23	968	28188	28188
 dodáváno do 30. 6. 2022!						
<p>Tento výrobek obsahuje světelné zdroje energetické třídy F</p> 						



Prosím, respektujte:

Při použití paspartového rámu se skříň rozšíří na vykazovanou šířku.

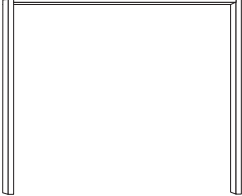

Paspartový rám pro skříně s posuvnými dveřmi, výška skříně 236 cm

s nebo bez osvětlení

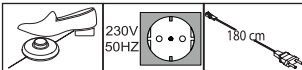
Popis	Rozměry v cm			Č. výr.	PG 1 CZK	PG 2 CZK
	B	v.	h			
 <p>bez osvětlení, Šířka na každé straně bočnice: 5 cm</p> <p>- for width 250 cm - for width 300 cm - for width 330 cm - for width 400 cm</p>						
 <p>Paspartový rám, Šířka na každé straně bočnice: 5 cm</p> <p>6 lights - for width 250 cm 6 lights - for width 300 cm 8 lights - for width 330 cm 8 lights - for width 400 cm</p>						
<p>Tento výrobek obsahuje světelné zdroje energetické třídy F</p> 						









Prosím, respektujte:

Při použití paspartového rámu se skříní rozšíří na vykazovanou šířku.

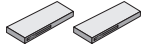

Horní rampy a paspartové rámy pro skříně s posuvnými dveřmi

s nebo bez osvětlení

Popis	Rozměry v cm			Č. výr.	PG 1 CZK	PG 2 CZK
	B	v.	h			
 <p>2dílná sada samočinného zásuvu s tlumením</p>						
- for 3-door units piece	24	2	11	363	2507	2507
 <p>- for 4-door units piece</p>	24	2	11	364	3524	3524
 <p>2dílná sada samočinného zásuvu s tlumením</p> <p style="text-align: right;">pair</p>	24	2	11	365	4540	4540
 <p>Kollisionsdämpfer</p> <p>- for 2-doors wardrobes 1 item</p> <p> Optimální funkce pouze ve spojení s tlumiči dovírání vnějších dveří</p> <p>- for 3-4 door wardrobes 2 items</p> <p> Optimální funkce pouze ve spojení s vnějším a středovým tlumením dveří!</p>	28	4	2	369		
	28	4	2	370		
 <p>horní rampy, bez osvětlení</p> <p>- for width 250 cm</p> <p>- for width 300 cm</p> <p>- for width 330 cm</p> <p>- for width 400 cm</p>	250	5	23	094	2778	2778
	300	5	23	095	2914	2914
	330	5	23	092	5285	5285
	400	5	23	093	5692	5692
 <p>s power LED osvětlením</p> <p>6 lights - for width 250 cm</p> <p>6 lights - for width 300 cm</p> <p>8 lights - for width 330 cm</p> <p>8 lights - for width 400 cm</p>	250	5	23	097	13891	13891
	300	5	23	098	13891	13891
	330	5	23	099	17076	17076
	400	5	23	091	17753	17753

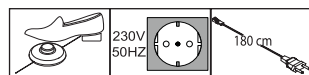

Tento výrobek obsahuje světelné zdroje energetické třídy F





Doplňkové prvky

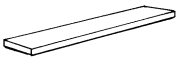
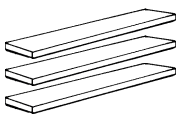
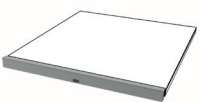

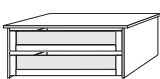
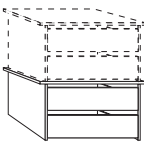
pro skříně s posuvnými a křídlovými dveřmi

Popis	Rozměry v cm			Č. výr.	PG 1 CZK	PG 2 CZK
	B	v.	h			
 <p>1 police</p> <p>- for compartment width 47.5 cm - for compartment width 80.1 cm - for compartment width 96.4 cm</p>	47,5	2,2	51,5	028	1287	1287
	80,1	2,2	51,5	320	1423	1423
	96,4	2,2	51,5	030	1558	1558
 <p>3 police</p> <p>- for compartment width 47.5 cm - for compartment width 80.1 cm - for compartment width 96.4 cm</p>	47,5	2,2	51,5	029	2168	2168
	80,1	2,2	51,5	321	2643	2643
	96,4	2,2	51,5	031	3049	3049
 <p>LED- světelný panel pro police</p> <p>1 item - for compartment width 47.5 cm 47,5 1 item - for compartment width 80.1 cm 80,1 1 item - for compartment width 96.4 cm 96,4</p> <p>2 items - for compartment width 47.5 cm 47,5 2 items - for compartment width 80.1 cm 80,1 2 items - for compartment width 96.4 cm 96,4</p> <p>3 items - for compartment width 47.5 cm 47,5 3 items - for compartment width 80.1 cm 80,1 3 items - for compartment width 96.4 cm 96,4</p> <p>Tento výrobek obsahuje světelný zdroj třídy energetické náročnosti F</p>	47,5	3	1	190	4337	4337
	80,1	3	1	199	4946	4946
	96,4	3	1	192	5082	5082
	47,5	3	1	193	6640	6640
	80,1	3	1	343	8877	8877
	96,4	3	1	342	9351	9351
	47,5	3	1	147	9893	9893
	80,1	3	1	149	12739	12739
	96,4	3	1	341	13349	13349
 <p>Šatní tyč</p> <p>- for compartment width 47.5 cm - for compartment width 80.1 cm - for compartment width 96.4 cm</p>	47,5	3	2	103	813	813
	80,1	3	2	104	813	813
	96,4	3	2	105	949	949
 <p>Zásuvkový nástavec se 2 výsuvy a skleněným čelem</p> <p>- for compartment width 47.5 cm - for compartment width 80.1 cm - for compartment width 96.4 cm</p>	47,5	41	51,5	047	7318	7318
	80,1	41	51,5	054	8877	8877
	96,4	41	51,5	061	9080	9080
 <p>Schubkasten-Einsatz mit 2 Auszügen mit Selbsteinzug und HOLZfront für Drehtüren- und Schwebetürenschränke, stapelbar und auf beliebiger Höhe einbaubar</p> <p>- for compartment width 80.1 cm - for compartment width 96.4 cm</p>	80,1	41	51,5	891		
	96,4	41	51,5	892		



Doplňkové prvky

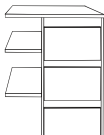
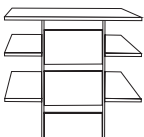
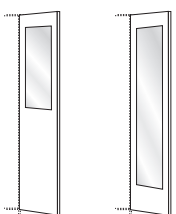

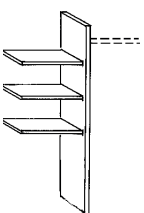
pro skříně s posuvnými a křídlovými dveřmi

Popis	Rozměry v cm			Č. výr.	PG 1 CZK	PG 2 CZK
	B	v.	h			
 <p>Zásuvkový nástavec se 3 výsuvy a dřevěným čelem</p> <p>- for compartment width 80.1 cm - for compartment width 96.4 cm</p> <p>Č. výr. 120</p>	80,1 96,4	89 89	51,5 51,5	120 111	11045 11790	11045 11790
 <p>Č. výr. 111</p>						
 <p>Vnitřní zrcadlo</p> <p>Č. výr. 046 Č. výr. 079</p>	36 36	80 173	1 1	046 079	2304 3930	1423 3930
 <p>vnitřní zrcadlo, vyklápěcí</p> <p> pouze ve spojení se skříněmi s posuvnými dveřmi!</p> <p>Č. výr. 080</p>	36	173	2	080	7318	7318
 <p>Šatní set sestává z:</p> <p>3 police 1 šatní tyč 1 středová stěna</p> <p>- for compartment width 80.1 cm - for compartment width 96.4 cm</p> <p>Lze použít oboustranně (pro levou i pravou stranu)!</p>	80,1 96,4	137 137	51,5 51,5	254 250	3795 3795	3795 3795

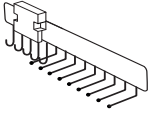
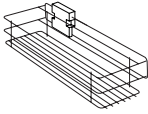
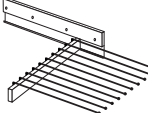

Doplňkové prvky

pro skříně s posuvnými a křídlovými dveřmi

Popis	Rozměry v cm			Č. výr.	PG 1 CZK	PG 2 CZK
	B	v.	h			
 <p>Výsuv na kravaty a opasky</p>	7	19	45	059	2372	2372
 <p>Výsuv pro uložení drobných doplňků</p>	16	9	45	476	2778	2778
 <p>Výsuvný věšák na kalhoty</p>	45	10	50	056	6098	6098
 <p>LED-vnitřní osvětlení skříně s čidlem pohybu, včetně baterie (nabíjení přes USB)</p>						
1 item	10	2	10	106	2236	2236
2 items	10	2	10	107	4337	4337
3 items	10	2	10	108	6505	6505
4 items	10	2	10	109	8606	8606



Futonová lůžka

Variabilní nastavení výšky lůžka, 4 polohy

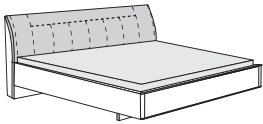
Popis	Plocha k ležení	Zastavěná plocha	Č. výr.	PG 1 CZK	PG 2 CZK	
Bočnice lůžka - výška 43 cm  lůžko bez nožiček, Čalounění čela lůžka v - Faux leather magnolia výška čela lůžka: 91 cm výška čela u nohou: 43 cm výška bočnice lůžka: 43 cm	160 x 190	169 x 208	466	31915	32999	
	160 x 200	169 x 218	467	31915	32999	
	160 x 210	169 x 228	468	34151	34896	
	160 x 220	169 x 238	469	34151	34896	
	180 x 190	189 x 208	431	31915	32999	
	180 x 200	189 x 218	432	31915	32999	
	180 x 210	189 x 228	433	34151	34896	
	180 x 220	189 x 238	434	34151	34896	
	200 x 190	209 x 208	435	31915	32999	
	200 x 200	209 x 218	436	31915	32999	
	200 x 210	209 x 228	437	34151	34896	
	200 x 220	209 x 238	438	34151	34896	
	- Faux leather white	160 x 190	169 x 208	672	31915	32999
	160 x 200	169 x 218	673	31915	32999	
	160 x 210	169 x 228	674	34151	34896	
	160 x 220	169 x 238	675	34151	34896	
	180 x 190	189 x 208	676	31915	32999	
	180 x 200	189 x 218	677	31915	32999	
	180 x 210	189 x 228	678	34151	34896	
	180 x 220	189 x 238	679	34151	34896	
	- textilní kůže champagner	160 x 190	169 x 208	236	31915	32999
	160 x 200	169 x 218	237	31915	32999	
	160 x 210	169 x 228	238	34151	34896	
	160 x 220	169 x 238	239	34151	34896	
	180 x 190	189 x 208	240	31915	32999	
	180 x 200	189 x 218	241	31915	32999	
	180 x 210	189 x 228	242	34151	34896	
	180 x 220	189 x 238	243	34151	34896	
200 x 190	209 x 208	244	31915	32999		
200 x 200	209 x 218	245	31915	32999		
200 x 210	209 x 228	246	34151	34896		
200 x 220	209 x 238	247	34151	34896		



Futonová lůžka

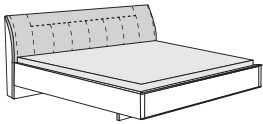

Variabilní nastavení výšky lůžka, 4 polohy

Popis	Plocha k ležení	Zastavěná plocha	Č. výr.	PG 1 CZK	PG 2 CZK	
Bočnice lůžka - výška 48 cm						
 <p>lůžko bez nožiček, Čalounění čela lůžka v</p> <p>- Faux leather magnolia</p> <p>výška čela lůžka: 97 cm výška čela u nohou: 48 cm výška bočnice lůžka: 48 cm</p>	160 x 190	169 x 208	601	32999	34151	
	160 x 200	169 x 218	602	32999	34151	
	160 x 210	169 x 228	603	35235	35981	
	160 x 220	169 x 238	607	35235	35981	
	180 x 190	189 x 208	608	32999	34151	
	180 x 200	189 x 218	609	32999	34151	
	180 x 210	189 x 228	610	35235	35981	
	180 x 220	189 x 238	611	35235	35981	
	200 x 190	209 x 208	614	32999	34151	
	200 x 200	209 x 218	615	32999	34151	
	200 x 210	209 x 228	616	35235	35981	
	200 x 220	209 x 238	617	35235	35981	
	- Faux leather white	160 x 190	169 x 208	638	32999	34151
	160 x 200	169 x 218	639	32999	34151	
160 x 210	169 x 228	640	35235	35981		
160 x 220	169 x 238	641	35235	35981		
180 x 190	189 x 208	642	32999	34151		
180 x 200	189 x 218	646	32999	34151		
180 x 210	189 x 228	653	35235	35981		
180 x 220	189 x 238	654	35235	35981		
- textilní kůže champagner	160 x 190	169 x 208	248	32999	34151	
160 x 200	169 x 218	249	32999	34151		
160 x 210	169 x 228	251	35235	35981		
160 x 220	169 x 238	252	35235	35981		
180 x 190	189 x 208	253	32999	34151		
180 x 200	189 x 218	255	32999	34151		
180 x 210	189 x 228	256	35235	35981		
180 x 220	189 x 238	257	35235	35981		
200 x 190	209 x 208	258	32999	34151		
200 x 200	209 x 218	259	32999	34151		
200 x 210	209 x 228	260	35235	35981		
200 x 220	209 x 238	261	35235	35981		



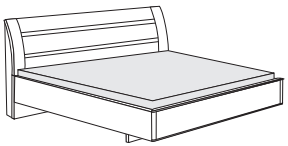
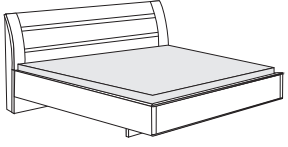

Futonová lůžka

Variabilní nastavení výšky lůžka, 4 polohy

Popis	Plocha k ležení	Zastavěná plocha	Č. výr.	PG 1 CZK	PG 2 CZK
Bočnice lůžka - výška 43 cm  lůžko bez nožiček, Čelo lůžka v masivním provedení a 2 nikami výška čela lůžka: 92 cm výška čela u nohou: 43 cm výška bočnice lůžka: 43 cm	160 x 190	169 x 208	700	32660	35642
	160 x 200	169 x 218	701	32660	35642
	160 x 210	169 x 228	702	34490	37065
	160 x 220	169 x 238	703	34490	37065
	180 x 190	189 x 208	704	32660	35642
	180 x 200	189 x 218	705	32660	35642
	180 x 210	189 x 228	706	34490	37065
	180 x 220	189 x 238	707	34490	37065
	200 x 190	209 x 208	708	32660	35642
	200 x 200	209 x 218	709	32660	35642
	200 x 210	209 x 228	710	34490	37065
	200 x 220	209 x 238	711	34490	37065
	Bočnice lůžka - výška 48 cm  lůžko bez nožiček, Čelo lůžka v masivním provedení a 2 nikami výška čela lůžka: 97 cm výška čela u nohou: 48 cm výška bočnice lůžka: 48 cm	160 x 190	169 x 208	712	33609
160 x 200		169 x 218	713	33609	36387
160 x 210		169 x 228	714	35913	38217
160 x 220		169 x 238	715	35913	38217
180 x 190		189 x 208	716	33609	36387
180 x 200		189 x 218	717	33609	36387
180 x 210		189 x 228	718	35913	38217
180 x 220		189 x 238	719	35913	38217
200 x 190		209 x 208	720	33609	36387
200 x 200		209 x 218	721	33609	36387
200 x 210		209 x 228	722	35913	38217
200 x 220		209 x 238	723	35913	38217
 Osvětlení pro lůžka z masivního dřeva s dvojím dělením - 2set, montáž zezadu čela lůžka Tento výrobek obsahuje světelný zdroj třídy energetické náročnosti E				102	6979

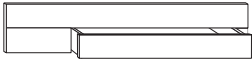
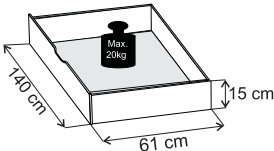

Doplňkové prvky pro lůžka

Popis	Rozměry v cm			Č. výr.	PG 1 CZK	PG 2 CZK
	B	v.	h			
 <p>Velký úložný prostor pod lžkem včetně doplnění soklu, pár</p>						
 <p>k dispozici pouze pro lůžka s „plovoucím“ rámem a výškou bočnice 48 cm</p>						
 <p>pro výšku bočnice lůžka 48 cm</p>						
- for bed surface area 160 x 190 cm	140	15	61	809	13688	13688
- for bed surface area 160 x 200 cm	140	15	61	810	13688	13688
- for bed surface area 160 x 210 cm	140	15	61	811	13688	13688
- for bed surface area 160 x 220 cm	140	15	61	812	13688	13688
- for bed surface area 180 x 190 cm	140	15	61	813	13688	13688
- for bed surface area 180 x 200 cm	140	15	61	814	13688	13688
- for bed surface area 180 x 210 cm	140	15	61	815	13688	13688
- for bed surface area 180 x 220 cm	140	15	61	816	13688	13688
- for bed surface area 200 x 190 cm	140	15	61	817	13688	13688
- for bed surface area 200 x 200 cm	140	15	61	818	13688	13688
- for bed surface area 200 x 210 cm	140	15	61	819	13688	13688
- for bed surface area 200 x 220 cm	140	15	61	820	13688	13688



Futonová lůžka

Variabilní nastavení výšky lůžka, 4 polohy

Bočnice lůžka - výška 43 cm

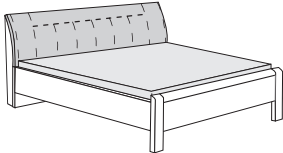
Popis	Plocha k ležení	Zastavěná plocha	Č. výr.	PG 1 CZK	PG 2 CZK	
 <p>- Faux leather magnolia</p> <p>výška čela lůžka: 91 cm výška čela u nohou: 45 cm výška bočnice lůžka: 43 cm</p>	160 x 190	169 x 208	270	27849	28527	
	160 x 200	169 x 218	271	27849	28527	
	160 x 210	169 x 228	272	30018	30763	
	160 x 220	169 x 238	273	30018	30763	
	180 x 190	189 x 208	274	27849	28527	
	180 x 200	189 x 218	275	27849	28527	
	180 x 210	189 x 228	278	30018	30763	
	180 x 220	189 x 238	279	30018	30763	
	200 x 190	209 x 208	276	27849	28527	
	200 x 200	209 x 218	277	27849	28527	
	200 x 210	209 x 228	281	30018	30763	
	200 x 220	209 x 238	282	30018	30763	
	- Faux leather white	160 x 190	169 x 208	296	27849	28527
		160 x 200	169 x 218	297	27849	28527
		160 x 210	169 x 228	298	30018	30763
		160 x 220	169 x 238	299	30018	30763
180 x 190		189 x 208	300	27849	28527	
180 x 200		189 x 218	301	27849	28527	
180 x 210		189 x 228	302	30018	30763	
180 x 220		189 x 238	303	30018	30763	
- textilní kůže champagner	160 x 190	169 x 208	200	27849	28527	
	160 x 200	169 x 218	201	27849	28527	
	160 x 210	169 x 228	202	30018	30763	
	160 x 220	169 x 238	203	30018	30763	
	180 x 190	189 x 208	204	27849	28527	
	180 x 200	189 x 218	205	27849	28527	
	180 x 210	189 x 228	206	30018	30763	
	180 x 220	189 x 238	207	30018	30763	
	200 x 190	209 x 208	208	27849	28527	
	200 x 200	209 x 218	209	27849	28527	
	200 x 210	209 x 228	222	30018	30763	
	200 x 220	209 x 238	223	30018	30763	



Futonová lůžka

Variabilní nastavení výšky lůžka, 4 polohy

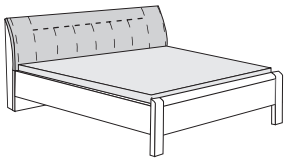

Bočnice lůžka - výška 48 cm

Popis	Plocha k ležení	Zastavěná plocha	Č. výr.	PG 1 CZK	PG 2 CZK	
 <p>výška čela lůžka: 96 cm výška čela u nohou: 52 cm výška bočnice lůžka: 48 cm</p>	- Faux leather magnolia	160 x 190	169 x 208	346	28934	29679
	160 x 200	169 x 218	347	28934	29679	
	160 x 210	169 x 228	348	30763	31915	
	160 x 220	169 x 238	349	30763	31915	
	180 x 190	189 x 208	350	28934	29679	
	180 x 200	189 x 218	351	28934	29679	
	180 x 210	189 x 228	356	30763	31915	
	180 x 220	189 x 238	357	30763	31915	
	200 x 190	209 x 208	648	28934	29679	
	200 x 200	209 x 218	649	28934	29679	
	200 x 210	209 x 228	651	30763	31915	
	200 x 220	209 x 238	652	30763	31915	
	- Faux leather white	160 x 190	169 x 208	664	28934	29679
	160 x 200	169 x 218	665	28934	29679	
	160 x 210	169 x 228	666	30763	31915	
	160 x 220	169 x 238	667	30763	31915	
180 x 190	189 x 208	668	28934	29679		
180 x 200	189 x 218	669	28934	29679		
180 x 210	189 x 228	670	30763	31915		
180 x 220	189 x 238	671	30763	31915		
- textilní kůže champagner	160 x 190	169 x 208	224	28934	29679	
160 x 200	169 x 218	225	28934	29679		
160 x 210	169 x 228	226	30763	31915		
160 x 220	169 x 238	227	30763	31915		
180 x 190	189 x 208	228	28934	29679		
180 x 200	189 x 218	229	28934	29679		
180 x 210	189 x 228	230	30763	31915		
180 x 220	189 x 238	231	30763	31915		
200 x 190	209 x 208	232	28934	29679		
200 x 200	209 x 218	233	28934	29679		
200 x 210	209 x 228	234	30763	31915		
200 x 220	209 x 238	235	30763	31915		

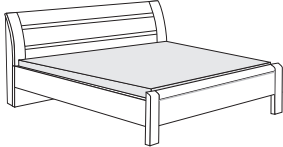
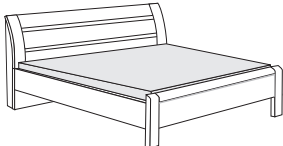

Postele

Variabilní nastavení výšky lůžka, 4 polohy

Popis	Plocha k ležení	Zastavěná plocha	Č. výr.	PG 1 CZK	PG 2 CZK	
Bočnice lůžka - výška 43 cm						
 <p>Čelo lůžka v masivním provedení a 2 nikami</p> <p>výška čela lůžka: 92 cm výška čela u nohou: 45 cm výška bočnice lůžka: 43 cm</p>	160 x 190	169 x 208	548	28527	31170	
	160 x 200	169 x 218	549	28527	31170	
	160 x 210	169 x 228	550	30424	32999	
	160 x 220	169 x 238	551	30424	32999	
	180 x 190	189 x 208	447	28527	31170	
	180 x 200	189 x 218	448	28527	31170	
	180 x 210	189 x 228	449	30424	32999	
	180 x 220	189 x 238	450	30424	32999	
	200 x 190	209 x 208	451	28527	31170	
	200 x 200	209 x 218	452	28527	31170	
	200 x 210	209 x 228	453	30424	32999	
	200 x 220	209 x 238	454	30424	32999	
	Bočnice lůžka - výška 48 cm					
	 <p>Čelo lůžka v masivním provedení a 2 nikami</p> <p>výška čela lůžka: 97 cm výška čela u nohou: 52 cm výška bočnice lůžka: 48 cm</p>	160 x 190	169 x 208	552	29340	31915
		160 x 200	169 x 218	553	29340	31915
		160 x 210	169 x 228	554	31508	34151
160 x 220		169 x 238	555	31508	34151	
180 x 190		189 x 208	540	29340	31915	
180 x 200		189 x 218	541	29340	31915	
180 x 210		189 x 228	542	31508	34151	
180 x 220		189 x 238	543	31508	34151	
200 x 190		209 x 208	544	29340	31915	
200 x 200		209 x 218	545	29340	31915	
200 x 210		209 x 228	546	31508	34151	
200 x 220		209 x 238	547	31508	34151	
 <p>Osvětlení pro čelo lůžka z masivního dřeva s dvojím dělením - 2set, montáž zezadu čela lůžka</p> <p>Tento výrobek obsahuje světelný zdroj třídy energetické náročnosti E</p>			102	6979	6979	



Postele

Variabilní nastavení výšky lůžka, 4 polohy

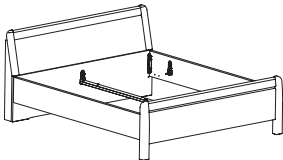
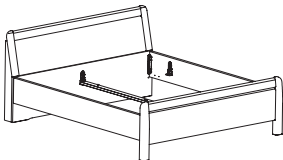
Popis	Plocha k ležení	Zastavěná plocha	Č. výr.	PG 1 CZK	PG 2 CZK	
Bočnice lůžka - výška 43 cm						
 <p>Dřevěné čelo lůžka</p> <p>- without bedding box in headboard</p> <p>výška čela lůžka: 91 cm výška čela u nohou: 62 cm výška bočnice lůžka: 43 cm</p>	180 x 190	189 x 210	854	28188	30018	
	180 x 200	189 x 220	855	28188	30018	
	180 x 210	189 x 230	856	30424	32254	
	180 x 220	189 x 240	857	30424	32254	
	200 x 190	209 x 210	858	28188	30018	
	200 x 200	209 x 220	859	28188	30018	
	200 x 210	209 x 230	860	30424	32254	
	200 x 220	209 x 240	861	30424	32254	
	<hr/>					
	- with bedding box in headboard	180 x 190	189 x 225	862	35642	37742
		180 x 200	189 x 235	863	35642	37742
		180 x 210	189 x 245	864	37742	39978
		180 x 220	189 x 255	865	37742	39978
		200 x 190	209 x 225	866	35642	37742
		200 x 200	209 x 235	867	35642	37742
		200 x 210	209 x 245	868	37742	39978
	200 x 220	209 x 255	869	37742	39978	
<hr/>						
Bočnice lůžka - výška 48 cm						
 <p>Dřevěné čelo lůžka</p> <p>- without bedding box in headboard</p> <p>výška čela lůžka: 96 cm výška čela u nohou: 62 cm výška bočnice lůžka: 48 cm</p>	180 x 190	189 x 208	309	29340	31170	
	180 x 200	189 x 218	314	29340	31170	
	180 x 210	189 x 228	325	31508	33473	
	180 x 220	189 x 238	331	31508	33473	
	200 x 190	209 x 210	643	29340	31170	
	200 x 200	209 x 220	644	29340	31170	
	200 x 210	209 x 230	645	31508	33473	
	200 x 220	209 x 240	647	31508	33473	
	<hr/>					
	- with bedding box in headboard	180 x 190	189 x 225	377	36726	38759
		180 x 200	189 x 235	381	36726	38759
		180 x 210	189 x 245	382	38759	40995
		180 x 220	189 x 255	389	38759	40995
		200 x 190	209 x 225	656	36726	38759
		200 x 200	209 x 235	657	36726	38759
		200 x 210	209 x 245	658	38759	40995
	200 x 220	209 x 255	659	38759	40995	







Komfortní postele

Variabilní nastavení výšky lůžka, 4 polohy

Popis	Plocha k ležení	Zastavěná plocha	Č. vyr.	PG 1 CZK	PG 2 CZK
 <p>Komfortní jednolůžko</p> <p>výška čela lůžka: 85 cm výška čela u nohou: 59 cm výška bočnice lůžka: 48 cm</p>	90 x 190	99 x 197	210	24461	26697
	90 x 200	99 x 207	211	24461	26697
	90 x 210	99 x 217	212	26697	28527
	90 x 220	99 x 227	213	26697	28527
	100 x 190	109 x 197	214	24461	26697
	100 x 200	109 x 207	215	24461	26697
	100 x 210	109 x 217	216	26697	28527
	100 x 220	109 x 227	217	26697	28527
	120 x 190	129 x 197	218	24461	26697
	120 x 200	129 x 207	219	24461	26697
	120 x 210	129 x 217	220	26697	28527
	120 x 220	129 x 227	221	26697	28527



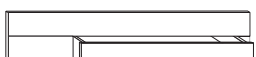
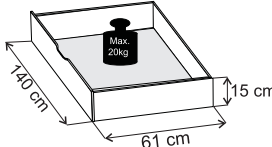

Doplňkové prvky pro lůžka

Popis	Rozměry v cm			Č. výr.	PG 1 CZK	PG 2 CZK	
	B	v.	h				
 <p>Power LED Flex osvětlení</p> <p>Tento výrobek obsahuje světelný zdroj třídy energetické náročnosti G</p>	pair	50	2	4	100	8131	8131
 <p>LED-závěsná světla, stříbrná</p> <p>Tento výrobek obsahuje světelný zdroj třídy energetické náročnosti F</p>	pair	50	2	4	101	6776	6776
 <p>Velký úložný prostor pod lžkem včetně doplnění soklu, pár</p>  <p>NEPLATÍ pro lůžka bez nožiček a komfortní jednolůžka!</p> <p> para altura costado cama 43 cm</p>							
<p>- for bed surface area 160 x 190 cm</p> <p>- for bed surface area 160 x 200 cm</p> <p>- for bed surface area 160 x 210 cm</p> <p>- for bed surface area 160 x 220 cm</p>		140	15	61	371	13349	13349
		140	15	61	372	13349	13349
		140	15	61	373	13349	13349
		140	15	61	374	13349	13349
<p>- for bed surface area 180 x 190 cm</p> <p>- for bed surface area 180 x 200 cm</p> <p>- for bed surface area 180 x 210 cm</p> <p>- for bed surface area 180 x 220 cm</p>		140	15	61	375	13349	13349
		140	15	61	378	13349	13349
		140	15	61	379	13349	13349
		140	15	61	380	13349	13349
<p>- for bed surface area 200 x 190 cm</p> <p>- for bed surface area 200 x 200 cm</p> <p>- for bed surface area 200 x 210 cm</p> <p>- for bed surface area 200 x 220 cm</p>		140	15	61	424	13349	13349
		140	15	61	394	13349	13349
		140	15	61	425	13349	13349
		140	15	61	395	13349	13349
<p> pro výšku bočnice lůžka 48 cm</p>							
<p>- for bed surface area 160 x 190 cm</p> <p>- for bed surface area 160 x 200 cm</p> <p>- for bed surface area 160 x 210 cm</p> <p>- for bed surface area 160 x 220 cm</p>		140	15	61	396	13688	13688
		140	15	61	397	13688	13688
		140	15	61	398	13688	13688
		140	15	61	399	13688	13688
<p>- for bed surface area 180 x 190 cm</p> <p>- for bed surface area 180 x 200 cm</p> <p>- for bed surface area 180 x 210 cm</p> <p>- for bed surface area 180 x 220 cm</p>		140	15	61	400	13688	13688
		140	15	61	401	13688	13688
		140	15	61	402	13688	13688
		140	15	61	403	13688	13688
<p>- for bed surface area 200 x 190 cm</p> <p>- for bed surface area 200 x 200 cm</p> <p>- for bed surface area 200 x 210 cm</p> <p>- for bed surface area 200 x 220 cm</p>		140	15	61	404	13688	13688
		140	15	61	405	13688	13688
		140	15	61	406	13688	13688
		140	15	61	407	13688	13688



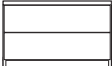

Doplňkový nábytek

Popis	Rozměry v cm			Č. výr.	PG 1 CZK	PG 2 CZK	
	B	v.	h				
 noční stolek, 1 zásuvka							
	Bočnice lůžka - výška 43 cm	piece pair	60 60	44 44	38 38	612 613	5692 10638
Bočnice lůžka - výška 48 cm	piece pair	60 60	48 48	38 38	680 681	5895 11045	6573 12197
	 Noční stolek se 2 zásuvkami						
	piece pair	40 40	40 40	36 36	632 633	5692 10503	6166 11722
	piece pair	60 60	40 40	36 36	623 624	6098 11451	6776 12874
 Noční stolek, 3 zásuvky horní zásuvka úzká							
	piece pair	40 40	50 50	36 36	630 631	6640 12603	7589 14365
	piece pair	60 60	50 50	36 36	636 637	7454 14162	8402 16330





Doplňkový nábytek

Popis	Rozměry v cm			Č. výr.	PG 1 CZK	PG 2 CZK	
	B	v.	h				
 <p>Deska no ního stolku, s policí z kouřového skla</p>							
	piece	40	27	14	116	3049	3185
	pair	40	27	14	117	5082	5624
	piece	60	27	14	118	3185	3388
	pair	60	27	14	119	5353	5760
 <p>Deska no ního stolku, s policí z kouřového skla a dotykovým osvětlením LED</p>							
	piece	40	27	14	112	6573	6573
	pair	40	27	14	113	10503	10638
	piece	60	27	14	114	6708	6708
	pair	60	27	14	115	10909	10909
<p>Tento výrobek obsahuje světelné zdroje energetické třídy G</p>							



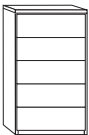
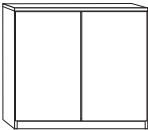
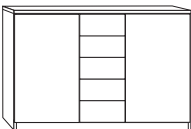
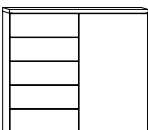
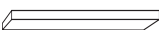

Doplňkový nábytek

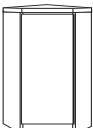
Všechny otoč. dveře s tlum. Dovíráním

Popis	Rozměry v cm			Č. výr.	PG 1 CZK	PG 2 CZK
	B	v.	h			
 <p>Skříň se zásuvkami, 5 výsuvů</p>	60	89	37	063	15585	17753
 <p>komoda, 2-dveřová, s jednou průběžnou vkladací policí</p>	93	89	37	062	19244	21819
 <p>Kombikomoda, v prostřední části 5 zásuvek, po stranách dvířka</p>	125	89	37	419	28527	32728
 <p>Kombikomoda malá vlevo 5 zásuvek, dveře vpravo, součástí 1 police</p>	93	89	37	024	22564	25207
 <p>Zásuvné police, masiv</p>	60 80	3 3	20 20	081 082	2168 2236	2372 3049
 <p>Závěsná skříňka s dvířky</p> <p>pair Unit, hinged left Unit, hinged right</p>	40 40 40	123 123 123	30 30 30	604 606 605	31508 15924 15924	32728 16669 16669
 <p>Rohová komoda</p> <p>LHH, for placing on left of bed LHH, for placing on right of bed</p>	61 61	89 89	61 61	686 688	17753 17753	20396 20396

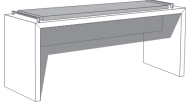
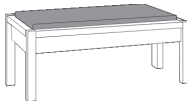

Doplňkový nábytek

Popis	Rozměry v cm			Č. výr.	PG 1 CZK	PG 2 CZK
	B	v.	h			
 <p>Odkládací lavice v dekoru se sedákem v textilní kůži</p> <ul style="list-style-type: none"> - with faux leather magnolia - with faux leather white - with faux leather champagne 	120	47	40	409	12400	12400
	120	47	40	410	12400	12400
	120	47	40	414	7725	12197
 <p>Lavice do šatny s čalouněním</p> <ul style="list-style-type: none"> - with faux leather magnolia - with faux leather white - with faux leather champagne 	120	46,3	40	412	34896	36726
	120	46,3	40	413	34896	36726
	120	46,3	40	427	28120	46348
 <p>Nástenné zrcadlo, sklo s broušenou fazetou</p>	60	80	3	088	3795	3795
 <p>Nástenné zrcadlo, sklo s broušenou fazetou</p>	110	85	3	650	6573	6573